

Фитинги Серия 2000

Присоединение: метрическая резьба (M5),
BSP (G1/8, G1/4, G3/8, G1/2, G3/4, G1),
BSPT (R1/8, R1/4, R3/8, R1/2, R3/4)



Серия 2000 включает прямые, Y-образные, T-образные и крестообразные фитинги с наружной или внутренней присоединительной резьбой до G1. Резьба трубная коническая по стандарту ISO 7 (BSPT); трубная цилиндрическая по стандарту ISO 228 (BSP).

ОСНОВНЫЕ ХАРАКТЕРИСТИКИ

Материалы	латунь OT58 покрытая никелем
Присоединение	трубная коническая ISO 7 (BSPT) трубная цилиндрическая ISO 228 (BSP)
Давление	40 бар
Рабочая среда	сжатый воздух и жидкости, совместимые с материалами фитингов
Температура	-40°C ÷ 120°C

РАЗРЕЗ

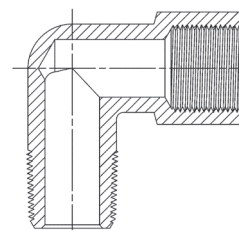

Фитинги Мод. 2500

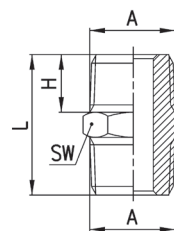

РАЗМЕРЫ

Мод.	A	H	L	SW	Вес (г)
2500 1/8	R1/8	7,5	19,5	12	9
2500 1/4	R1/4	11	27	14	16
2500 3/8	R3/8	11,5	28	17	21
2500 1/2	R1/2	14	33,5	22	41
2500 3/4	R3/4	16,5	40	27	80
2500 1	R1	19	45,5	34	125

Фитинги Мод. 2501

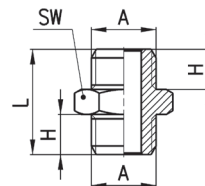

РАЗМЕРЫ

Мод.	A	H	L	SW	Вес (г)
2501 M5	M5	4	11,5	8	2
2501 1/8	G1/8	6	16,5	13	9
2501 1/4	G1/4	8	21	17	15
2501 3/8	G3/8	9	23	19	21
2501 1/2	G1/2	10	25,5	24	35

Фитинги Мод. 2510

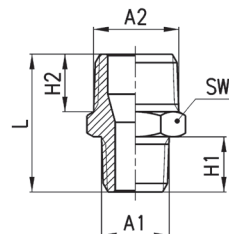

РАЗМЕРЫ

Мод.	A1	A2	H1	H2	L	SW	Вес (г)
2510 1/8-1/4	R1/8	R1/4	7,5	11	23,5	14	14
2510 1/8-3/8	R1/8	R3/8	7,5	11,5	24	17	18
2510 1/4-3/8	R1/4	R3/8	11	11,5	27,5	17	20
2510 1/4-1/2	R1/4	R1/2	11	14	30,5	22	34
2510 3/8-1/2	R3/8	R1/2	11,5	14	31	22	34
2510 1/2-3/4	R1/2	R3/4	14	16,5	37,5	27	67

Фитинги Мод. 2520

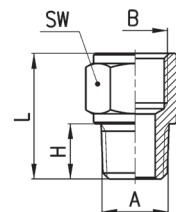

РАЗМЕРЫ						
Мод.	A	B	H	L	SW	Вес (г)
2520 1/8-1/8	R1/8	G1/8	7,5	17,5	13	9
2520 1/8-1/4	R1/8	G1/4	7,5	19	17	15
2520 1/8-3/8	R1/8	G3/8	7,5	20	20	19
2520 1/4-1/4	R1/4	G1/4	11	22,5	17	17
2520 1/4-3/8	R1/4	G3/8	11	23,5	20	21
2520 1/4-1/2	R1/4	G1/2	11	27,5	24	35
2520 3/8-3/8	R3/8	G3/8	11,5	24	20	23
2520 3/8-1/2	R3/8	G1/2	11,5	28	24	37
2520 1/2-1/2	R1/2	G1/2	14	30,5	24	41

Фитинги Мод. 2521

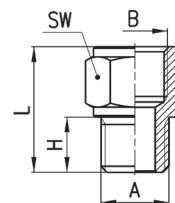

РАЗМЕРЫ						
Мод.	A	B	H	L	SW	Вес (г)
2521 M5-1/8	M5	G1/8	4	14	13	7
2521 1/8-1/8	G1/8	G1/8	6	16	13	8
2521 1/8-1/4	G1/8	G1/4	6	17,5	17	14
2521 1/8-3/8	G1/8	G3/8	6	18,5	20	30
2521 1/4-1/4	G1/4	G1/4	8	19,5	17	16
2521 1/4-3/8	G1/4	G3/8	8	20,5	20	20
2521 1/4-1/2	G1/4	G1/2	8	24,5	24	33
2521 3/8-3/8	G3/8	G3/8	9	21,5	20	22
2521 3/8-1/2	G3/8	G1/2	9	25,5	24	35
2521 1/2-1/2	G1/2	G1/2	10	26,5	24	36

Фитинги Мод. 2511

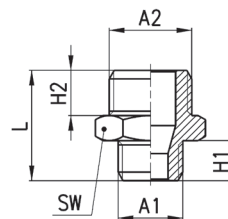

РАЗМЕРЫ

Мод.	A1	A2	H1	H2	L	SW	Вес (г)
2511 M5-1/8	M5	G1/8	4	6	14,5	13	8
2511 1/8-1/4	G1/8	G1/4	6	8	19	17	15
2511 1/8-3/8	G1/8	G3/8	6	9	20	19	19
2511 1/4-3/8	G1/4	G3/8	8	9	22	19	20
2511 1/4-1/2	G1/4	G1/2	8	10	23,5	24	32
2511 3/8-1/2	G3/8	G1/2	9	10	24,5	24	34

Фитинги Мод. 2525

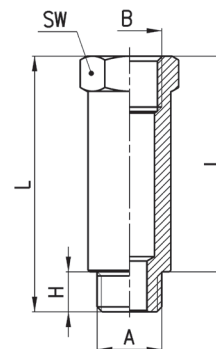

РАЗМЕРЫ

Мод.	A	B	H	I	L	SW	Вес (г)
2525 1/8-16	G1/8	G1/8	6	16	22	13	12
2525 1/8-36	G1/8	G1/8	6	36	42	13	24
2525 1/4-27	G1/4	G1/4	8	27	35	17	30
2525 1/4-43	G1/4	G1/4	8	43	51	17	45

Фитинги Мод. 2530

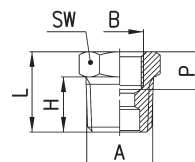

РАЗМЕРЫ

Мод.	A	B	H	L	P	SW	Вес (г)
2530 1/4-1/8	R1/4	G1/8	11	16	6	14	9
2530 3/8-1/8	R3/8	G1/8	11,5	16,5	8,5	17	17
2530 1/2-1/8	R1/2	G1/8	14	19,5	9,5	22	12
2530 3/8-1/4	R3/8	G1/4	11,5	16,5	7	17	34
2530 1/2-1/4	R1/2	G1/4	14	19,5	9,5	22	30
2530 1/2-3/8	R1/2	G3/8	14	19,5	8	22	24
2530 3/4-3/8	R3/4	G3/8	16,5	23	11,5	27	67
2530 3/4-1/2	R3/4	G1/2	16,5	23,5	9,5	27	48
2530 1-1/2	R1	G1/2	19	27	14	34	131

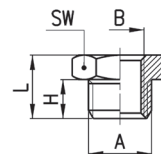
Фитинги Мод. 2531

РАЗМЕРЫ							
Мод.	A	B	H	L	SW	Вес (г)	
2531 1/8-M5	G1/8	M5	6	10,5	13	8	*
2531 1/4-1/8	G1/4	G1/8	8	13	17	11	*
2531 3/8-1/8	G3/8	G1/8	9	14	19	17	
2531 3/8-1/4	G3/8	G1/4	9	14	19	12	*
2531 1/2-1/8	G1/2	G1/8	10	15,5	24	32	
2531 1/2-1/4	G1/2	G1/4	10	15,5	24	29	
2531 1/2-3/8	G1/2	G3/8	10	15,5	24	22	*

* = модели с проходной резьбой

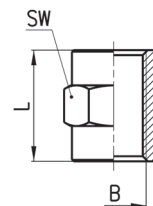
Фитинги Мод. 2543

РАЗМЕРЫ				
Мод.	B	L	SW	Вес (г)
2543 M5	M5	11	8	3
2543 1/8	G1/8	15	13	8
2543 1/4	G1/4	22	17	19
2543 3/8	G3/8	23	20	19
2543 1/2	G1/2	28	24	29

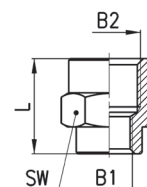
Фитинги Мод. 2553

РАЗМЕРЫ					
Мод.	B1	B2	L	SW	Вес (г)
2553 M5-1/8	M5	G1/8	13,5	13	7
2553 1/8-1/4	G1/8	G1/4	17	17	18
2553 1/8-3/8	G1/8	G3/8	18	20	18
2553 1/8-1/2	G1/8	G1/2	21,5	24	28
2553 1/4-3/8	G1/4	G3/8	19,5	20	21
2553 1/4-1/2	G1/4	G1/2	23	24	32
2553 3/8-1/2	G3/8	G1/2	24	24	31

Фитинги Мод. 2611

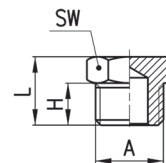

РАЗМЕРЫ

Мод.	A	H	L	SW	Вес (г)
2611 M5	M5	4	7,5	8	2
2611 1/8	G1/8	6	10,5	13	7
2611 1/4	G1/4	8	13	17	13
2611 3/8	G3/8	9	14	19	18
2611 1/2	G1/2	10	15,5	24	31
2611 1	G1	13	19	38	76

Фитинги Мод. 2610 3/4

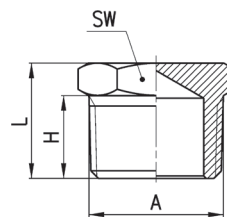

РАЗМЕРЫ

Мод.	A	H	L	SW	Вес (г)
2610 3/4	R3/4	16,5	23	27	61

Фитинги Мод. 2613

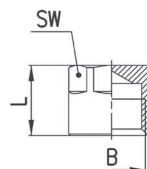

РАЗМЕРЫ

Мод.	B	L	SW	Вес (г)
2613 1/8	G1/8	11	12	6
2613 1/4	G1/4	13,5	15	13
2613 3/8	G3/8	15,5	18	19
2613 1/2	G1/2	22,5	19	33

Фитинги Мод. 2601

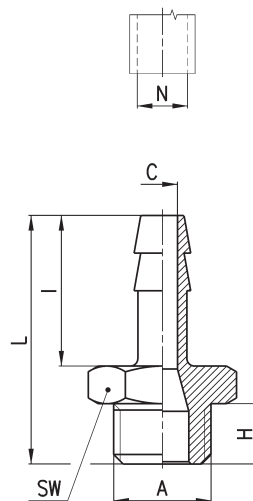

РАЗМЕРЫ								
Мод.	N	A	C	H	I	L	SW	Вес (г)
2601 2-M5	2	M5	1,2	4	8	16	8	2
2601 4,5-M5	4	M5	2,5	4	15	23	8	3
2601 7-1/8	7	G1/8	4	6	20	30	12	9
2601 7-1/4	7	G1/4	4	8	20	33	17	16
2601 8-1/8	8	G1/8	5	6	20	30	12	10
2601 9-1/8	9	G1/8	5,5	6	20	30	12	11
2601 9-1/4	9	G1/4	6	8	20	33	17	17
2601 9-3/8	9	G3/8	6	9	20	34	19	21
2601 12-1/4	12	G1/4	8,5	8	20	33	17	20
2601 12-3/8	12	G3/8	9	9	20	34	19	23
2601 12-1/2	12	G1/2	9	10	20	35,5	24	34
2601 17-3/8	17	G3/8	12	9	24	38	19	31
2601 17-1/2	17	G1/2	13	10	24	39,5	24	41

Фитинги Мод. 2013

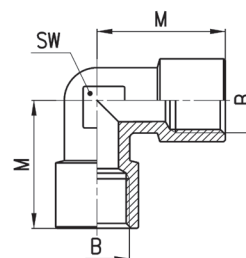

РАЗМЕРЫ				
Мод.	B	M	SW	Вес (г)
2013 1/8	G1/8	19	11	16
2013 1/4	G1/4	23	14	28
2013 3/8	G3/8	25	16	39
2013 1/2	G1/2	31,5	20	69

Фитинги Мод. 2010

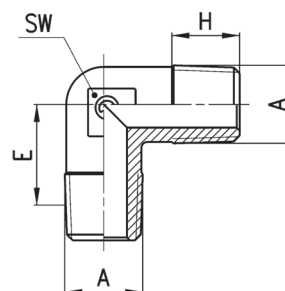

РАЗМЕРЫ

Мод.	A	E	H	SW	Вес (г)
2010 1/8	R1/8	11,5	7,5	9	10
2010 1/4	R1/4	13,5	11	12	18
2010 3/8	R3/8	15,5	11,5	14	28
2010 1/2	R1/2	16	14	16	47
2010 3/4	R3/4	19	16	25	103
2010 1	R1	23	17	30	183

Фитинги Мод. 2021 и 2020

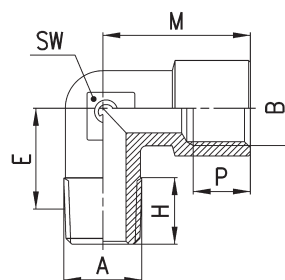

РАЗМЕРЫ

Мод.	A	B	E	H	M	P	SW	Вес (г)
2021 M5-M5	M5	M5	9	4	10,5	4,5	9	7
2020 1/8-1/8	R1/8	G1/8	11,5	8,5	19	6	11	17
2020 1/4-1/4	R1/4	G1/4	15	11	23	7	13	27
2020 3/8-3/8	R3/8	G3/8	15	11,5	25	8	15	33
2020 1/2-1/2	R1/2	G1/2	17,5	14	31,5	9,5	20	63
2020 3/4-3/4	R3/4	G3/4	19	16	36,5	16,5	25	126
2020 1-1	R1	G1	23	17	45	19	30	209

Фитинги Мод. 2050

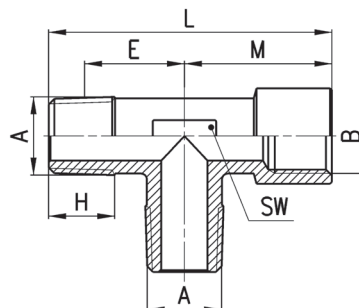

РАЗМЕРЫ

Мод.	A	B	E	H	L	M	SW	Вес (г)
2050 1/8-1/8	R1/8	G1/8	11,5	8,5	37	19	12	27
2050 1/4-1/4	R1/4	G1/4	15	11	46	23	13	35
2050 3/8-3/8	R3/8	G3/8	15	11,5	48,5	25	16	44
2050 1/2-1/2	R1/2	G1/2	17,5	14	60,5	31,5	20	83

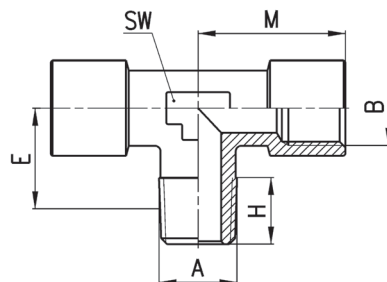
Фитинги Мод. 2060

РАЗМЕРЫ							
Мод.	A	B	E	H	M	SW	Вес (г)
2060 1/8-1/8	R1/8	G1/8	11,5	8,5	19	12	22
2060 1/4-1/4	R1/4	G1/4	15	11	23	13	38
2060 3/8-3/8	R3/8	G3/8	15	11,5	25	16	49
2060 1/2-1/2	R1/2	G1/2	17,5	14	31,5	20	89

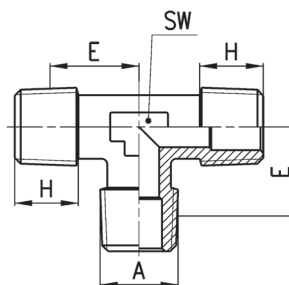
Фитинги Мод. 2080

РАЗМЕРЫ					
Мод.	A	E	H	SW	Вес (г)
2080 1/8	R1/8	11,5	7,5	9	14
2080 1/4	R1/4	13,5	11	12	25
2080 3/8	R3/8	15,5	11,5	14	39
2080 1/2	R1/2	16	14	16	82
2080 3/4	R3/4	19	16,2	25	135
2080 1	R1	23	17,5	30	239

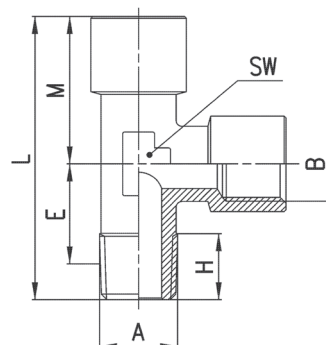
Фитинги Мод. 2070

РАЗМЕРЫ								
Мод.	A	B	E	H	L	M	SW	Вес (г)
2070 1/8-1/8	R1/8	G1/8	11,5	8,5	37	19	12	22
2070 1/4-1/4	R1/4	G1/4	15	11	46	23	13	37
2070 3/8-3/8	R3/8	G3/8	15	11,5	48,5	25	16	49
2070 1/2-1/2	R1/2	G1/2	17,5	14	60,5	31,5	20	89

Фитинги Мод. 2090

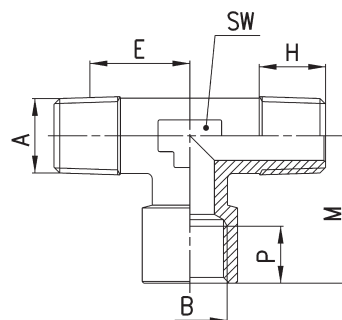

РАЗМЕРЫ								
Мод.	A	B	E	H	M	P	SW	Вес (г)
2090 1/8-1/8	R1/8	G1/8	11,5	8,5	19	6	12	22
2090 1/4-1/4	R1/4	G1/4	15	11	23	7	13	37
2090 3/8-3/8	R3/8	G3/8	15	11,5	25	8	16	44
2090 1/2-1/2	R1/2	G1/2	17,5	14	31,5	9,5	20	83
2090 3/4-3/4	R3/4	G3/4	19	16	36,5	16,5	25	156
2090 1-1	R1	G1	23	17,5	45	19	30	262

Фитинги Мод. 2003

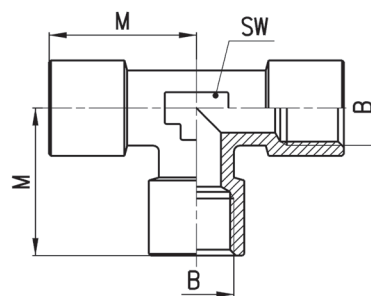

РАЗМЕРЫ				
Мод.	B	M	SW	Вес (г)
2003 1/8	G1/8	19	12	23
2003 1/4	G1/4	23	13	39
2003 3/8	G3/8	25	16	54
2003 1/2	G1/2	31,5	20	97

Фитинги Мод. 2040

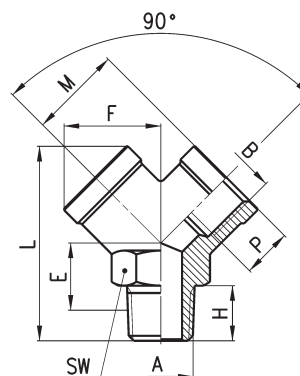

РАЗМЕРЫ										
Мод.	A	B	E	F	H	L	M	P	SW	Вес (г)
2040 1/8-1/8	R1/8	G1/8	9,5	14,5	8	32	14	8	13	22
2040 1/4-1/4	R1/4	G1/4	12	18	11	38	17,5	11	17	38
2040 3/8-3/8	R3/8	G3/8	13,5	20,5	11,5	42,5	19	11,5	20	52
2040 1/2-1/2	R1/2	G1/2	15,5	26,5	14	53	24,5	14	25	110

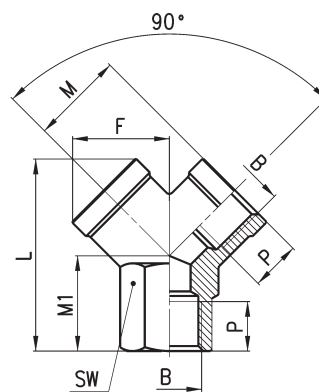
Фитинги Мод. 2043

РАЗМЕРЫ								
Мод.	B	F	L	M	M1	P	SW	Вес (г)
2043 1/8	G1/8	14,5	26,5	14	12	8	13	18
2043 1/4	G1/4	18	32	17,5	14	11	17	32
2043 3/8	G3/8	20,5	37	19	16	11,5	20	44
2043 1/2	G1/2	26,5	45	24,5	19	14	25	84

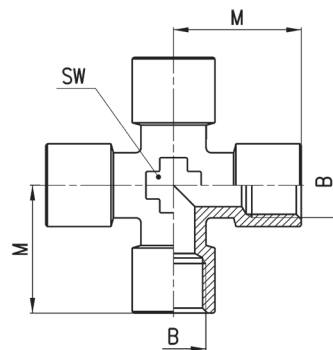
Фитинги Мод. 2033

РАЗМЕРЫ				
Мод.	B	M	SW	Вес (г)
2033 1/8	G1/8	19	12	27
2033 1/4	G1/4	23	14	51
2033 3/8	G3/8	25	16	70

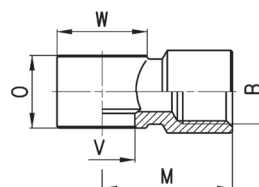
Фитинги Мод. 2023

РАЗМЕРЫ						
Мод.	B	M	O	V	W	Вес (г)
2023 M5-M5	M5	10,5	9	5,1	□ 9	6
2023 M5-M6	M6	10,5	9	5,1	□ 9	6
2023 1/8-1/8	G1/8	20	14,5	9,8	∅ 14	14
2023 1/4-1/4	G1/4	23,5	14,5	13,2	∅ 18	21
2023 3/8-3/8	G3/8	26,5	14,5	16,7	∅ 21	27

Для сборки с:
 • = Мод. 1631
 ° = Мод. SCU, SVU, SCO...
 * = Мод. 1631, 1635, SCU, SVU, SCO...
 ^ = Мод. 1635, SCU, SVU, SCO...

Коллекторы Мод. 3033

Коллекторы на 4 выхода с крепежными отверстиями
Материал: анодированный алюминий

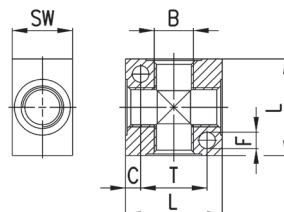

РАЗМЕРЫ

Мод.	B	C	F	L	T	SW	Вес (г)
3033 1/8	G1/8	4	4,5	25	17	16	18
3033 1/4	G1/4	5	5,5	32	22	20	35
3033 3/8	G3/8	7	5,5	40	26	25	73
3033 1/2	G1/2	8	5,5	50	34	30	137

Коллекторы Мод. 3043...D... - выходы с двух сторон

Коллектор с выходными отверстиями сверху и снизу.
Материал: анодированный алюминий

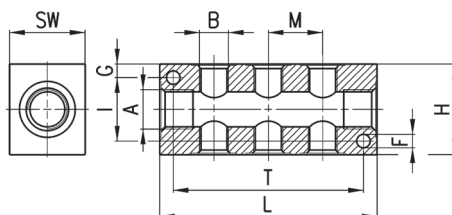

РАЗМЕРЫ

Мод.	A	Количество двух выходов (B)	B	F	G	H	I	L	M	T	SW	Вес (г)
3043 1/4-3D-1/8	1/4	3	1/8	4,5	4,5	30	21	72	18	63	20	85
3043 1/4-4D-1/8	1/4	4	1/8	4,5	4,5	30	21	90	18	81	20	107
3043 1/4-5D-1/8	1/4	5	1/8	4,5	4,5	30	21	108	18	99	20	128
3043 1/4-6D-1/8	1/4	6	1/8	4,5	4,5	30	21	126	18	117	20	151
3043 3/8-3D-1/4	3/8	3	1/4	5,5	6	40	28	92	24	75	25	177
3043 3/8-4D-1/4	3/8	4	1/4	5,5	6	40	28	116	24	99	25	224
3043 3/8-5D-1/4	3/8	5	1/4	5,5	6	40	28	140	24	123	25	270
3043 3/8-6D-1/4	3/8	6	1/4	5,5	6	40	28	164	24	147	25	315
3043 1/2-3D-3/8	1/2	3	3/8	5,5	6,5	50	37	104	26	85	30	287
3043 1/2-4D-3/8	1/2	4	3/8	5,5	6,5	50	37	130	26	111	30	356
3043 1/2-5D-3/8	1/2	5	3/8	5,5	6,5	50	37	156	26	137	30	427
3043 1/2-6D-3/8	1/2	6	3/8	5,5	6,5	50	37	182	26	163	30	495

Коллекторы Мод. 3053...L... - выходы с одной стороны

Коллекторы с выходными отверстиями только сверху.
 Материал: анодированный алюминий

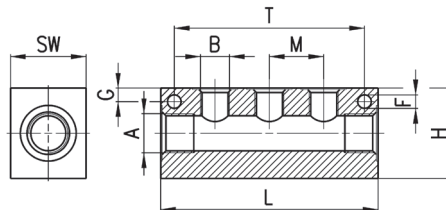
РАЗМЕРЫ

Мод.	A	Количество выходов (B)	B	F	G	H	L	M	T	SW	Вес (г)
3053 1/4-3L-1/8	1/4	3	1/8	4,5	4,5	30	72	18	63	20	92
3053 1/4-4L-1/8	1/4	4	1/8	4,5	4,5	30	90	18	81	20	116
3053 1/4-5L-1/8	1/4	5	1/8	4,5	4,5	30	108	18	99	20	140
3053 1/4-6L-1/8	1/4	6	1/8	4,5	4,5	30	126	18	117	20	164
3053 3/8-3L-1/4	3/8	3	1/4	5,5	6	40	92	24	75	25	191
3053 3/8-4L-1/4	3/8	4	1/4	5,5	6	40	116	24	99	25	243
3053 3/8-5L-1/4	3/8	5	1/4	5,5	6	40	140	24	123	25	294
3053 3/8-6L-1/4	3/8	6	1/4	5,5	6	40	164	24	147	25	345
3053 1/2-3L-3/8	1/2	3	3/8	5,5	6,5	50	104	26	85	30	313
3053 1/2-4L-3/8	1/2	4	3/8	5,5	6,5	50	130	26	111	30	395
3053 1/2-5L-3/8	1/2	5	3/8	5,5	6,5	50	156	26	137	30	474
3053 1/2-6L-3/8	1/2	6	3/8	5,5	6,5	50	182	26	163	30	551